

Information Security Questionnaire Results

The following pages contain charts that represent the results of the findings of the Information Security Survey that was given to a total of 488 students from three schools. Sixty-one surveys were thrown out because of inappropriate answers, lack of answers, incorrect age or grade level, etc., leaving a total of 427 valid surveys. Information not included in the compilation is:

- Gender of those surveyed: There were 214 males and 213 females.
- The chart concerning whether or not the students had a computer was left out because that information could be found on later answers as well, but 408 students did have computers and 19 did not.
- The question concerning which Internet Service Provider. The top five ISPs were:
 - America Online
 - Net Nicto—a local ISP for one of the middle schools
 - MSN
 - Yahoo DSL
 - Insight BB—a local cable company's ISP
- The question concerning specific rules for using the computer was also left out because this was a written answer rather than a more simple answer. The five main rules for using the computer were:
 - Time limits
 - Staying off inappropriate websites
 - Staying away from pornographic websites
 - Asking for permission before using the computer
 - Restrictions on chat rooms or instant messenger

Student Age Distribution

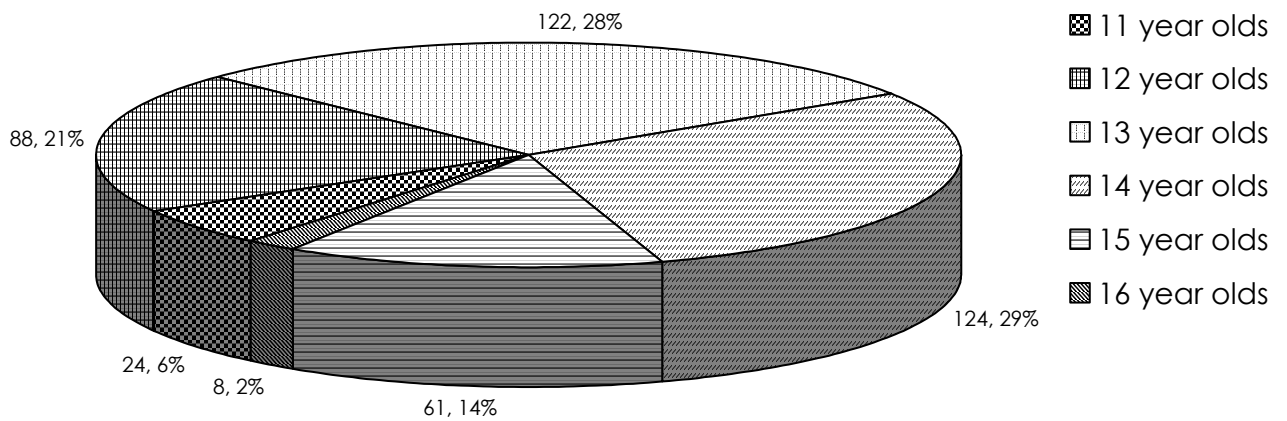

Racial Background

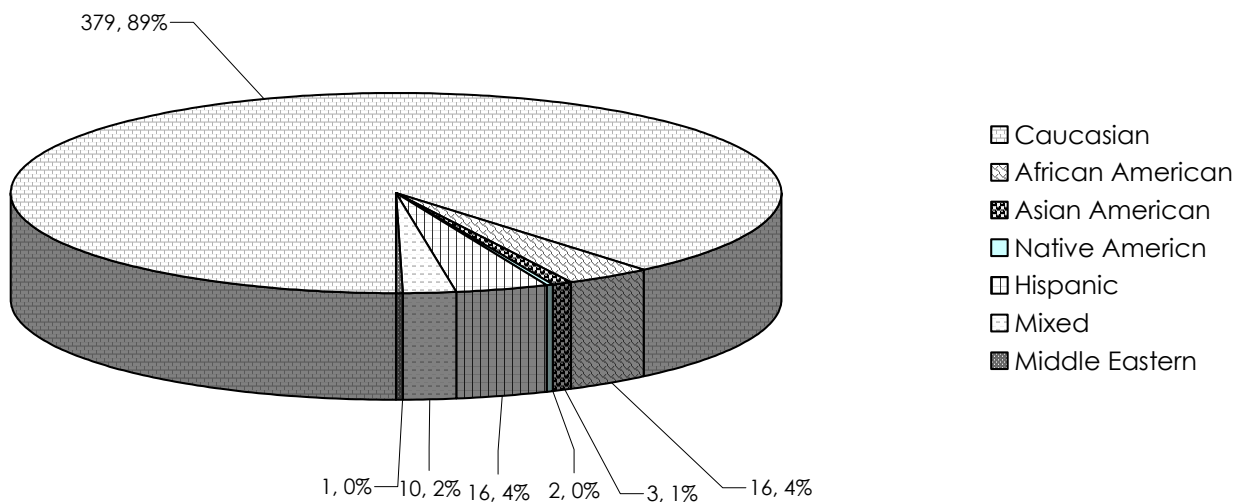

Grade Level Distribution

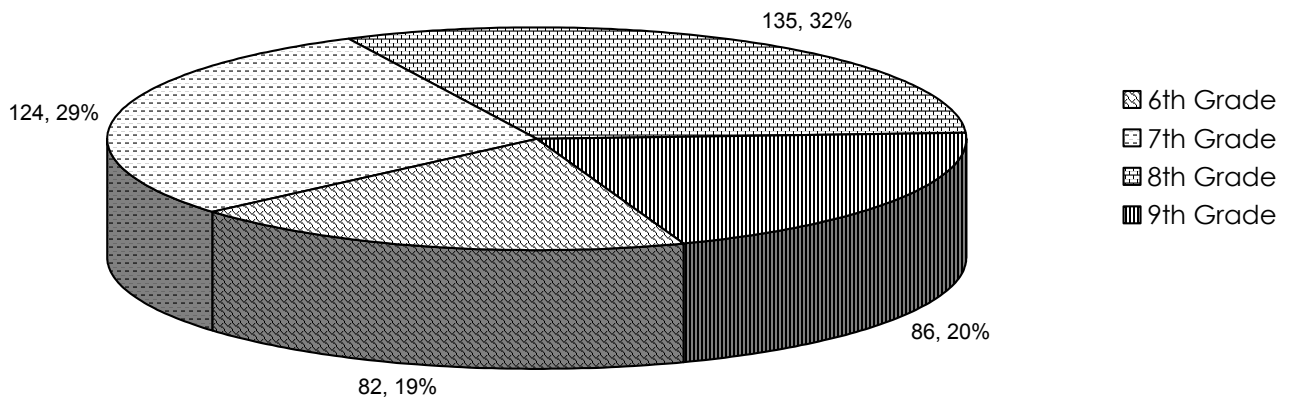

Does Your Home have Internet Access?

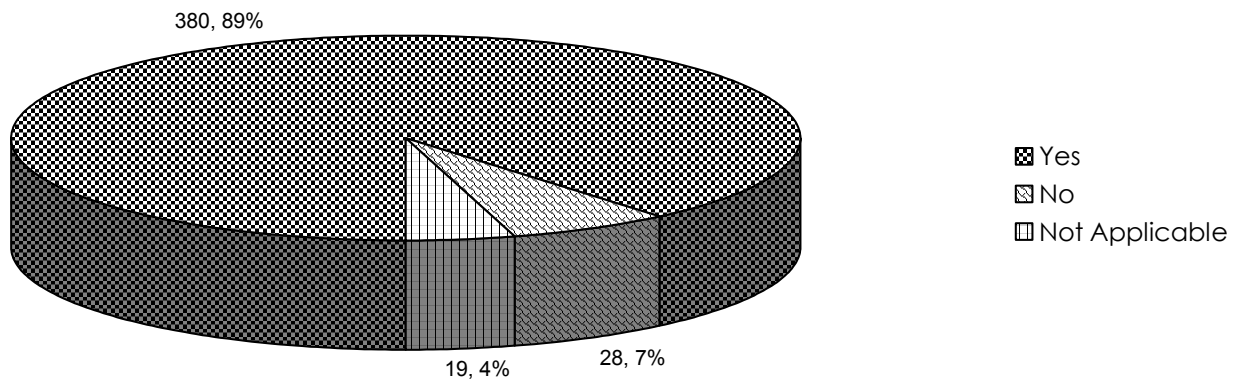

What Type of Connection does your Home Have?

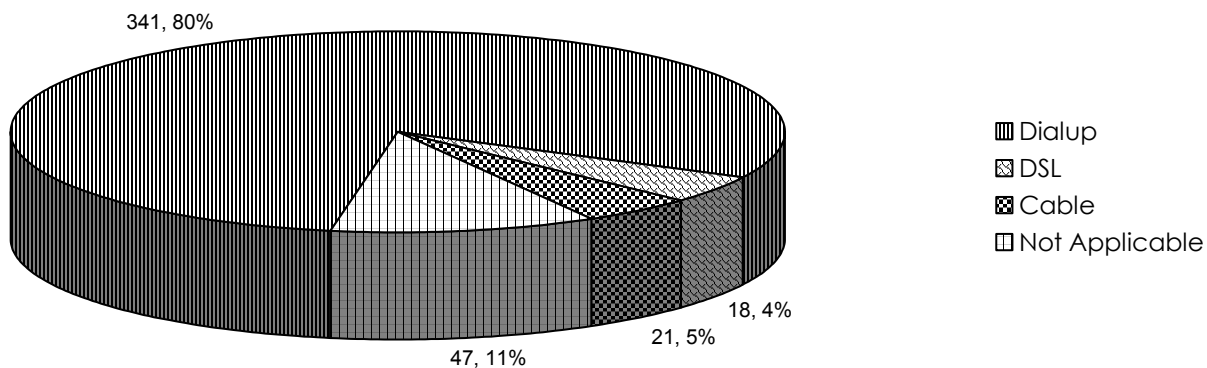

Do Your Parents Use Parental Controls?

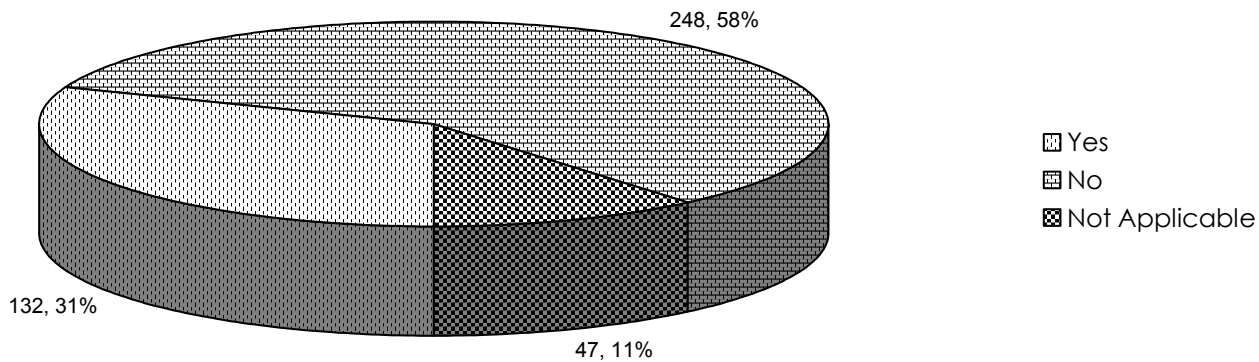

What Are The Top Three Things That You Do Most Often While Online At Home?

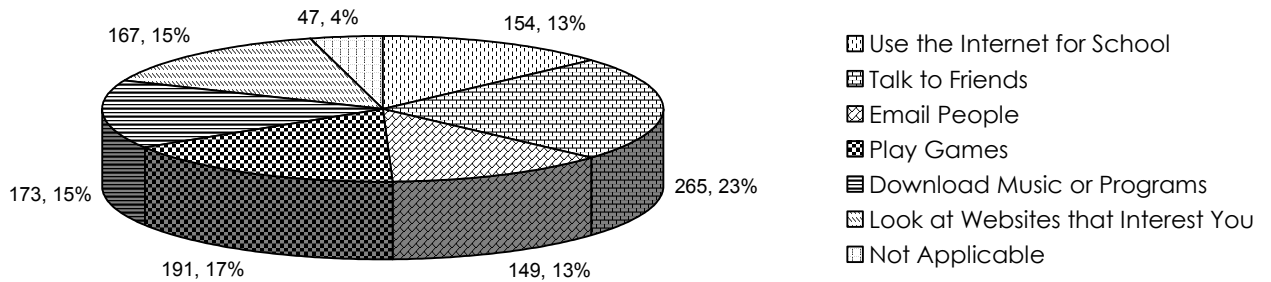

Would You Say You Use Your Home Computer More For School Work Or More For Your Own Personal Use?

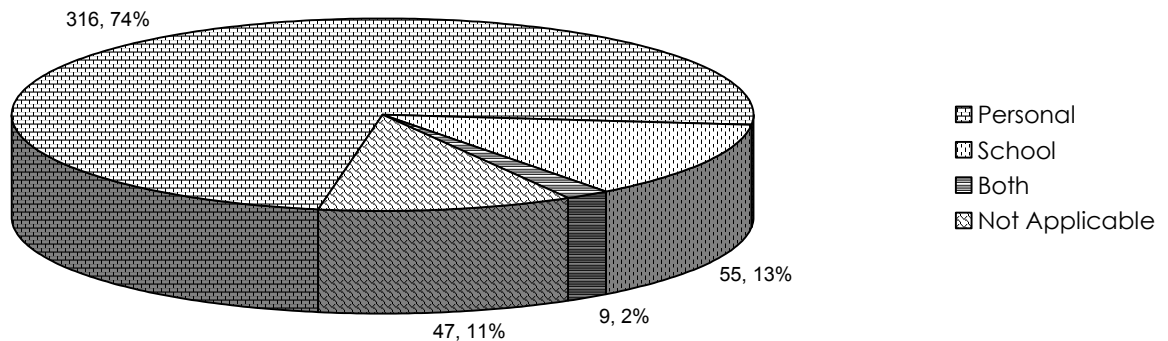

Do Your Parents Have Any Rules For Using The Computer?

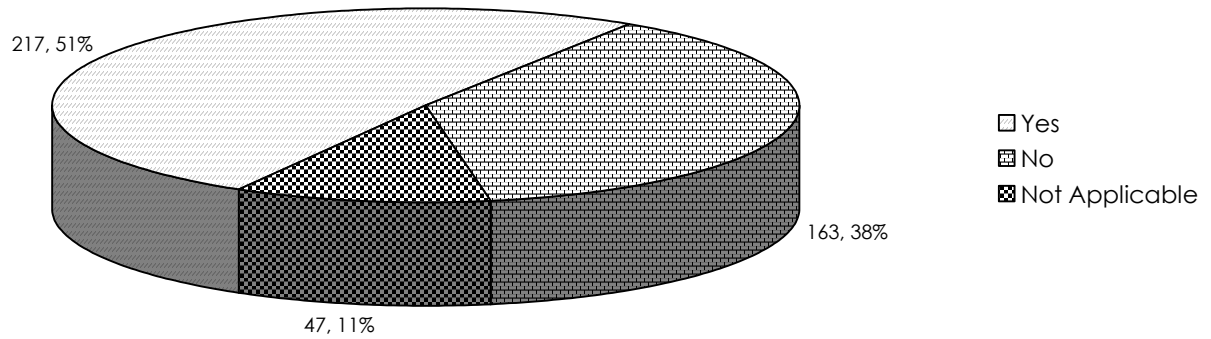

I Have Used The Internet To Download Music Or Programs Using File-Sharing Programs Like Kazaa Or Audio Galaxy

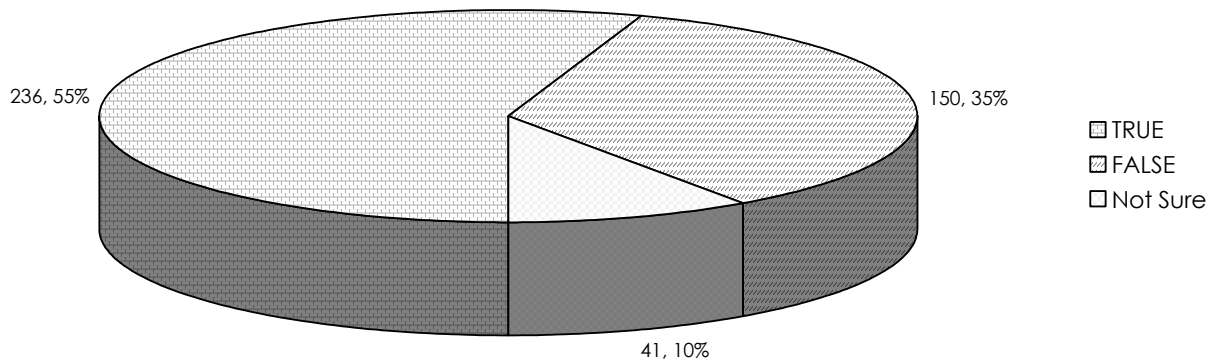

I Check For Viruses When I Download A File Or Open An Email Attachment

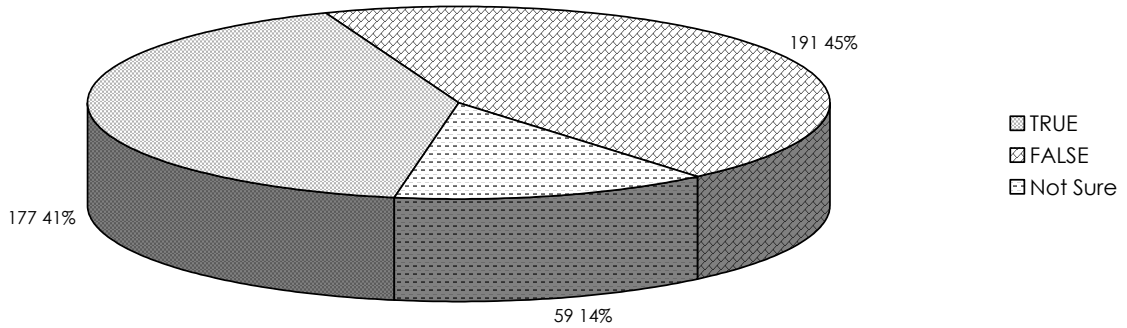

My School Uses Programs To Keep Me From Looking At Sites That Are Inappropriate For School

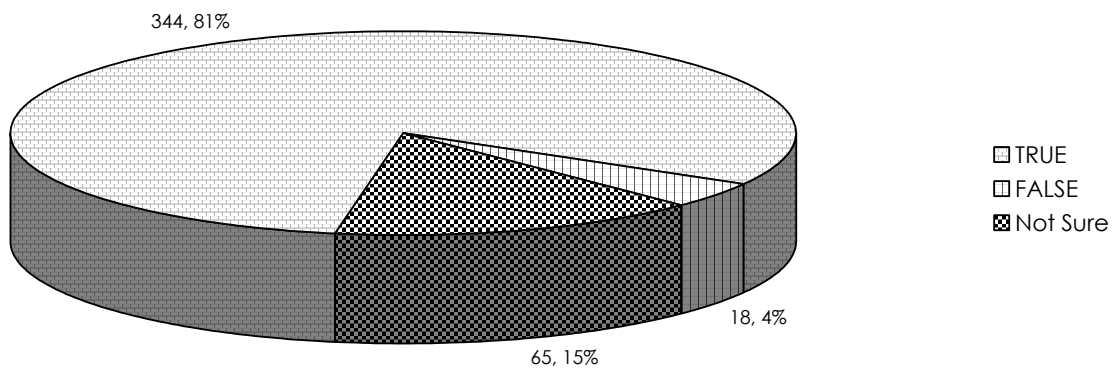

There Is Nothing Wrong With Downloading Music, Videos, Or Programs For Free Without Permission.

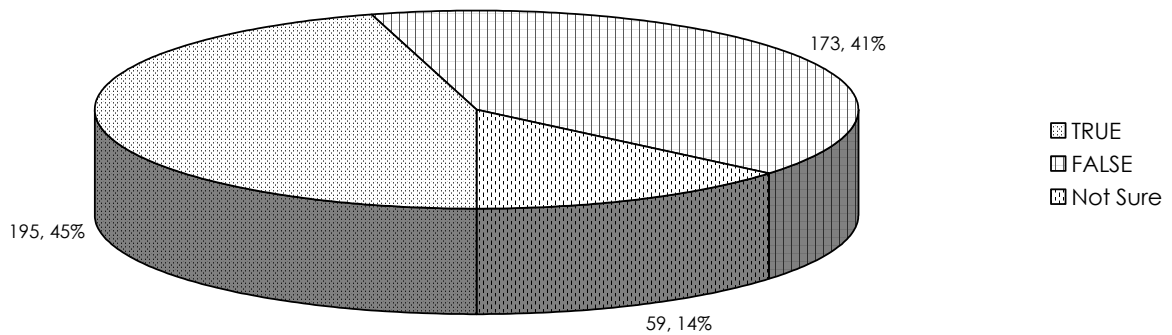

When I Have An Important Document For School, I Save The File In More Than One Location, Such As On The Hard Drive And Onto A Floppy Disk Or CD

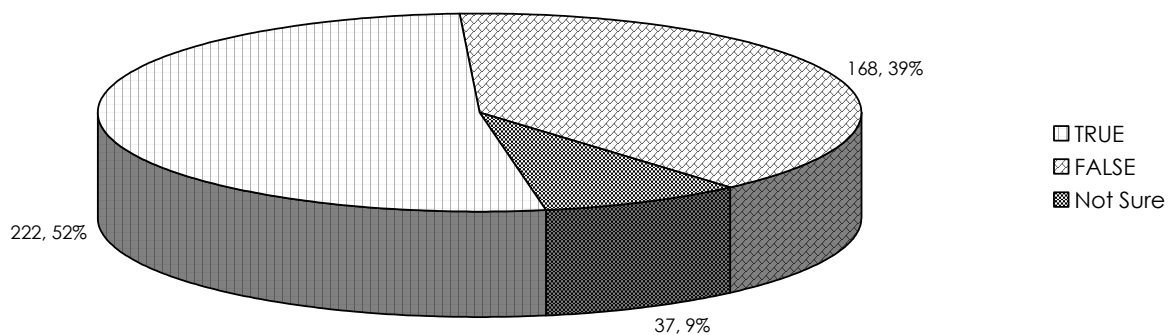

I Have Been Harassed While Online By People I Did Not Know

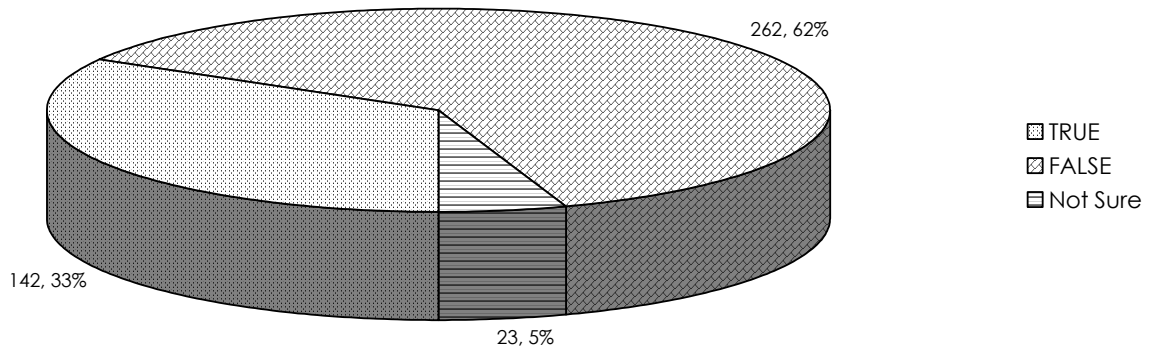

I Have Been Sent Inappropriate Material While Online

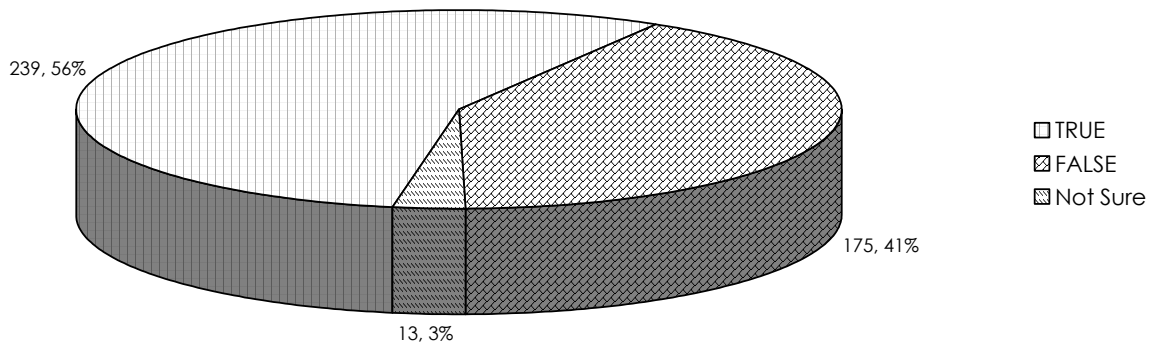

I Told My Parents Or Someone In Authority When I Was Harassed Or Sent Inappropriate Material While Online.

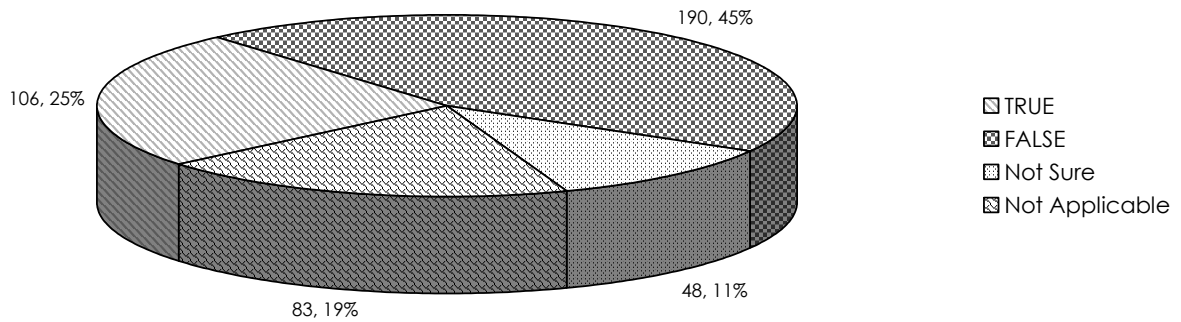

I Use Instant Messaging Programs Such As AOL Instant Messenger, MSN Messenger, Yahoo, ICQ, Etc.

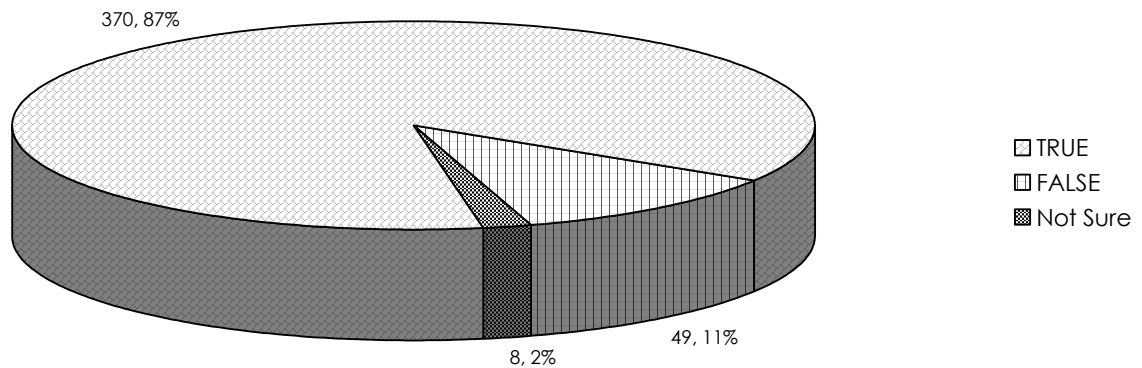

I Use Chat Rooms

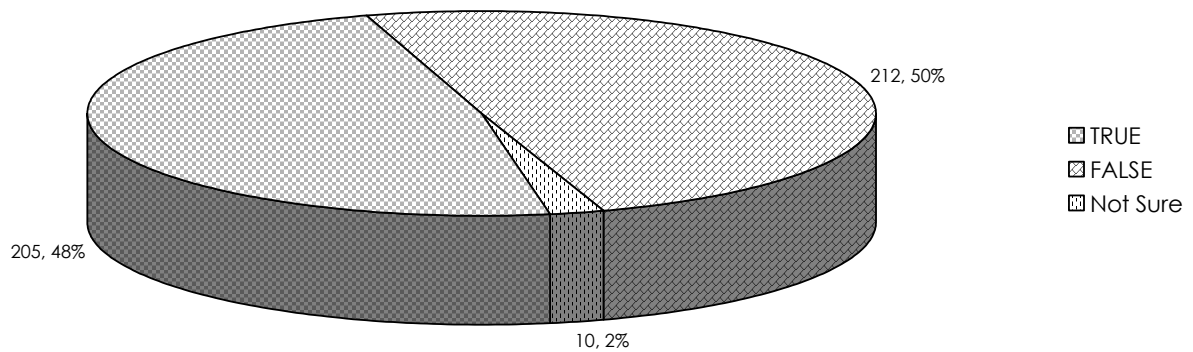

I Chat With People Online Whom I Have Never Met In Person

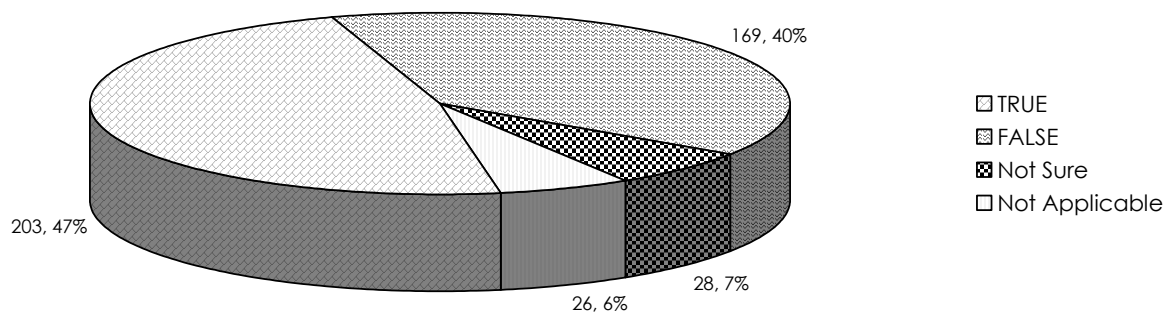

Sometimes I Am Not Sure If I Can Trust That The Person I Am Chatting With Is Who They Say They Are

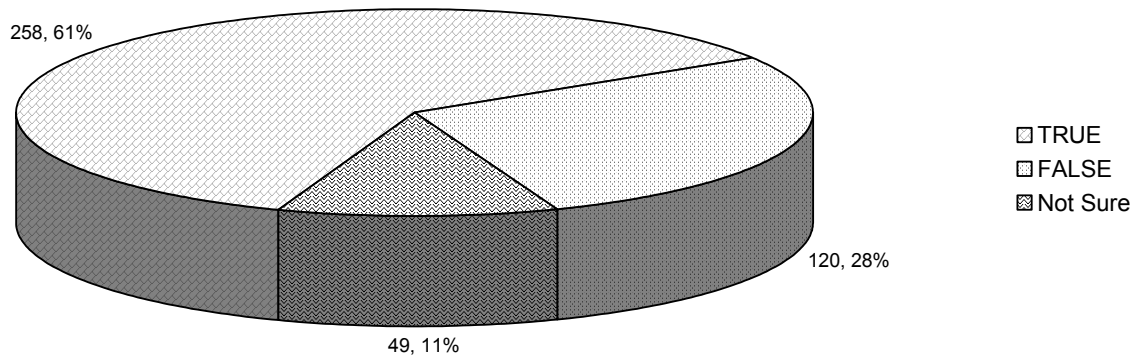

I Have Bought Things Online

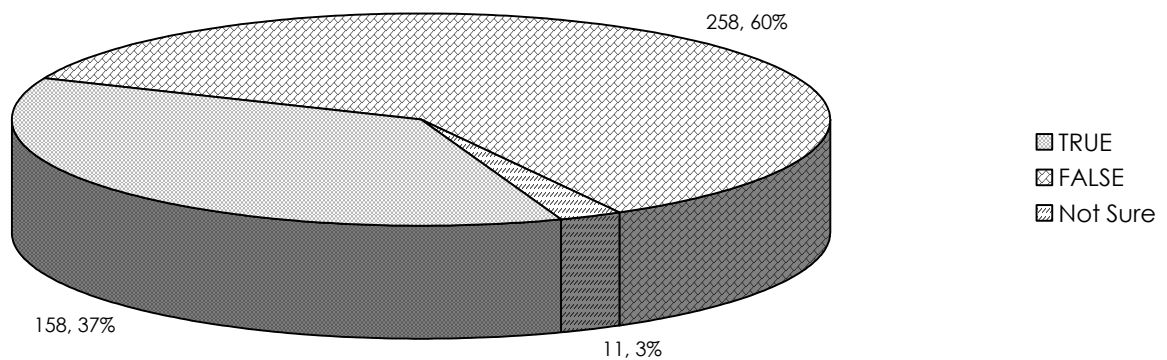

I Have Bought Things Online Without A Parent's Permission

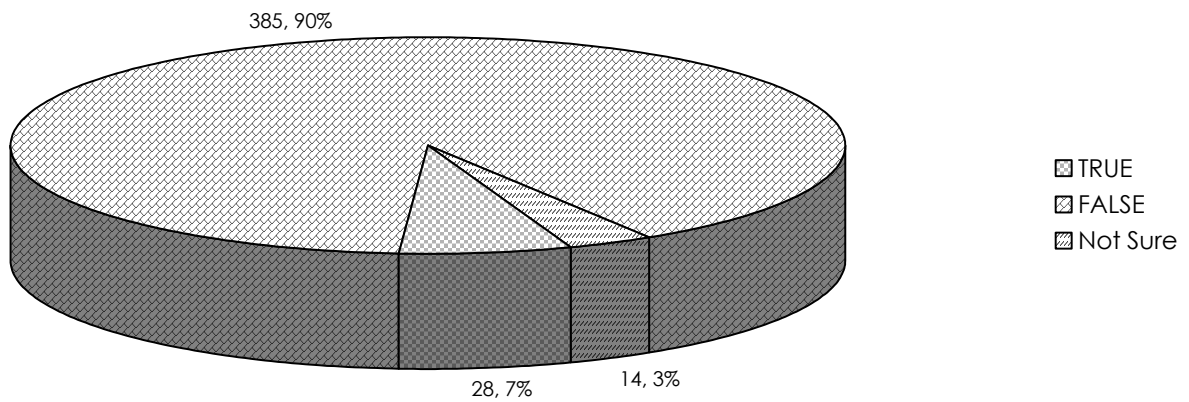

I Know How To Tell If A Website Is Secure And Safe To Give Information To

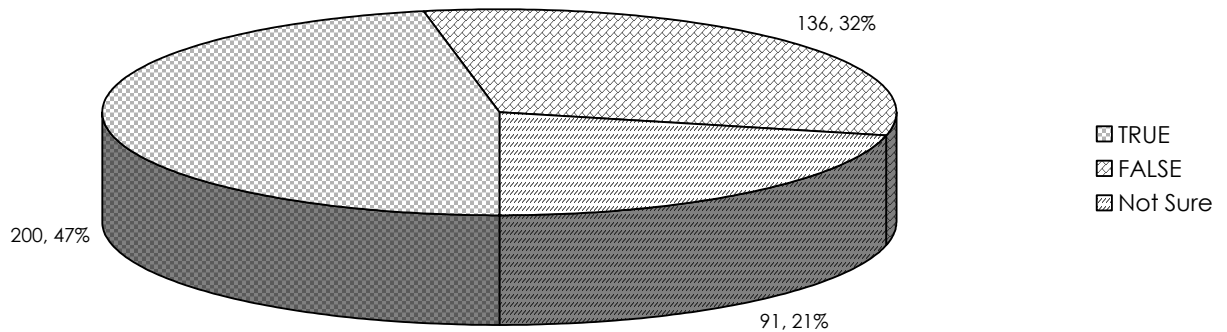

A Parent Or I Check For Patches Or Other Downloads For My Computer To Make It Safer From Hackers

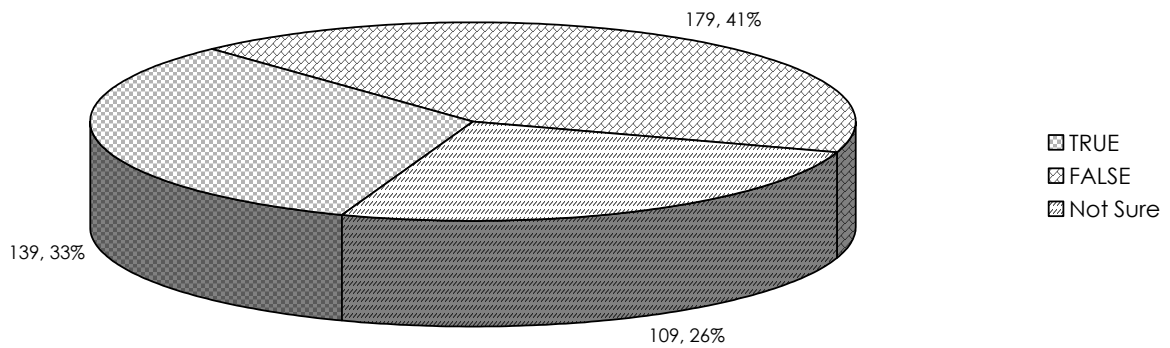

I Disconnect From The Internet When I Am Not Using It Rather Than Putting Up An Away Message Or Simply Leaving It Connected

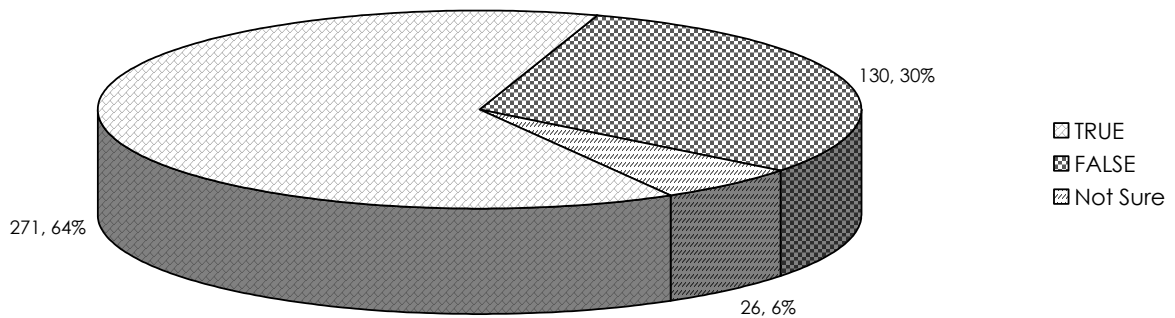

I Have Used Or Have Come In Contact With A Firewall Or Filtering Software

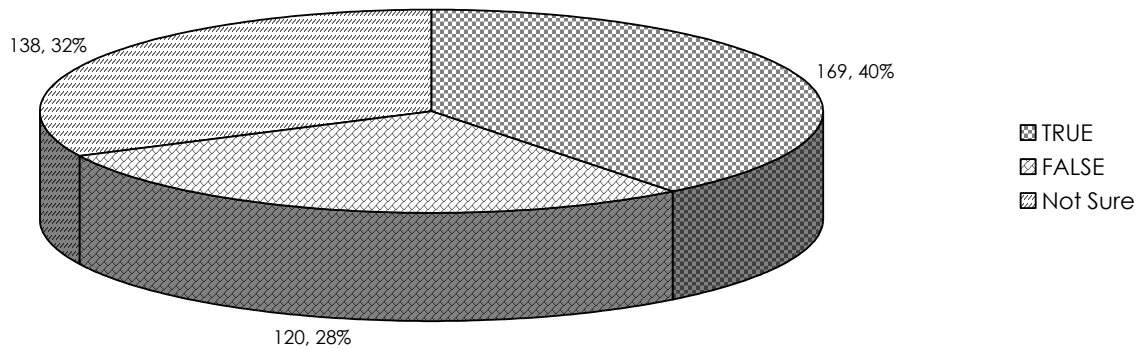

I Use The Same Password For Everything That Needs A Password

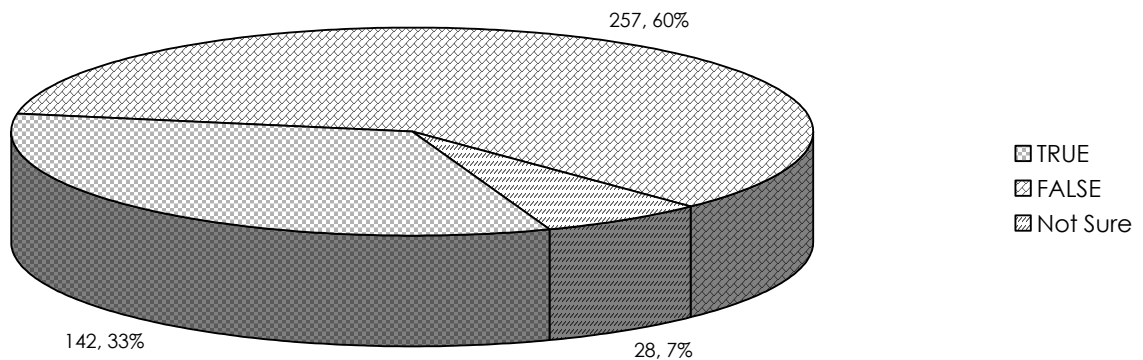

I Have Used The Internet To Make Fun Of Other People Or Say Bad Things About Them Because I Knew No One Would Know It Was I Who Did It

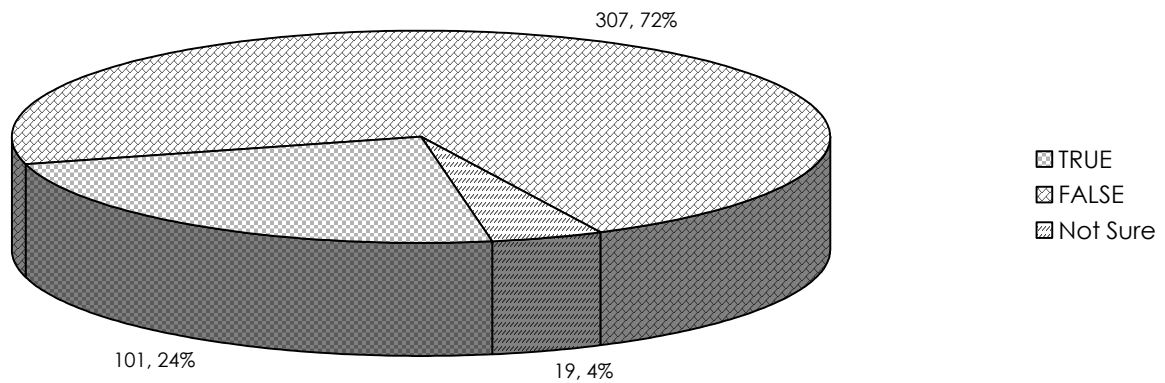

When The Allotted Trial Time Has Passed On Freeware/ Shareware, I Always Either Delete The Program Or Purchase It

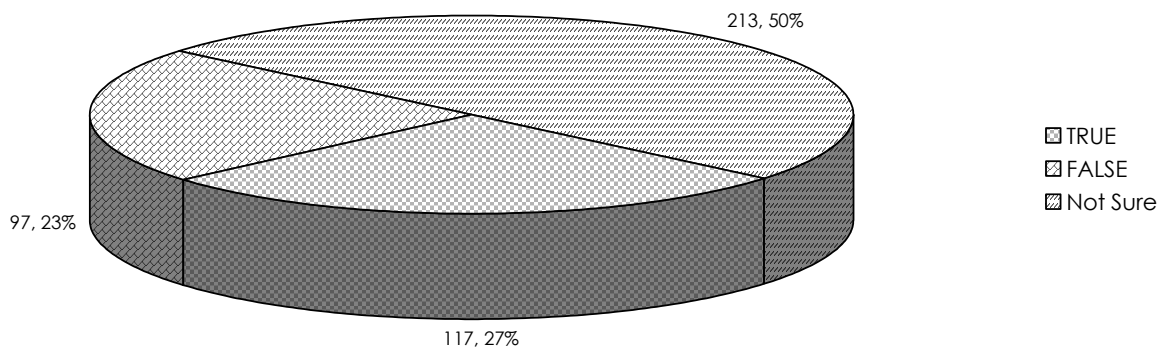

When The Allotted Trial Time Has Passed On Freeware/ Shareware, I Have Downloaded Or Borrowed A "Crack" For It So I Could Continue Using It For Free

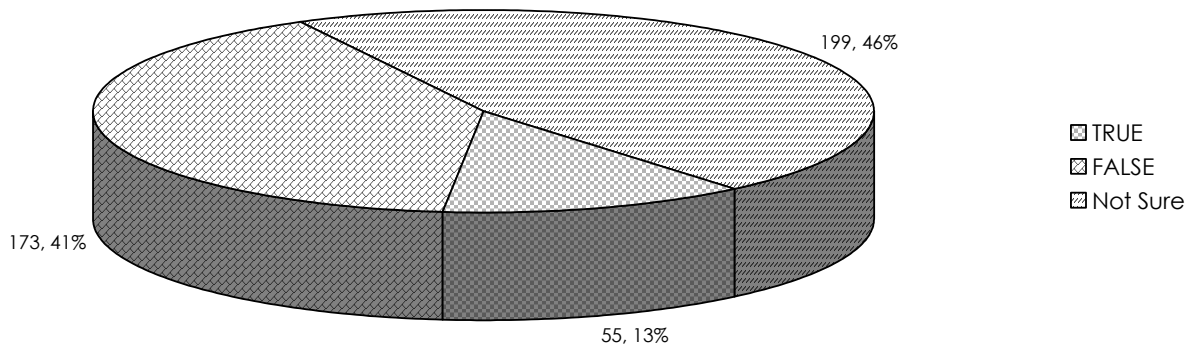

I Am Concerned About Someone Stealing Information About Myself When I Am Online

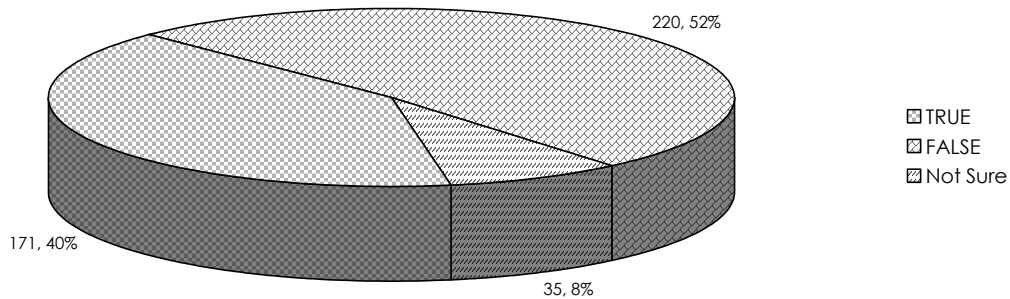

You Can't Get In Trouble For Changing Someone's Website Because It's Not "Real"

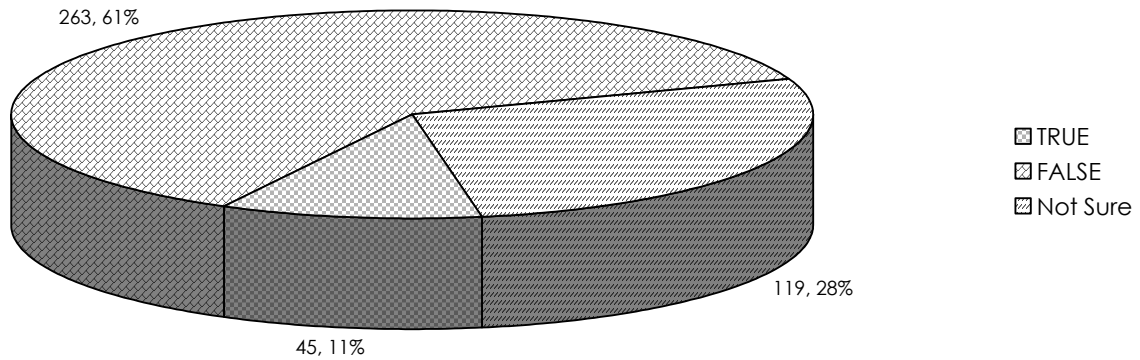

If You See Something From A Website That You Want To Put Into A Paper You're Writing For School, You Typically:

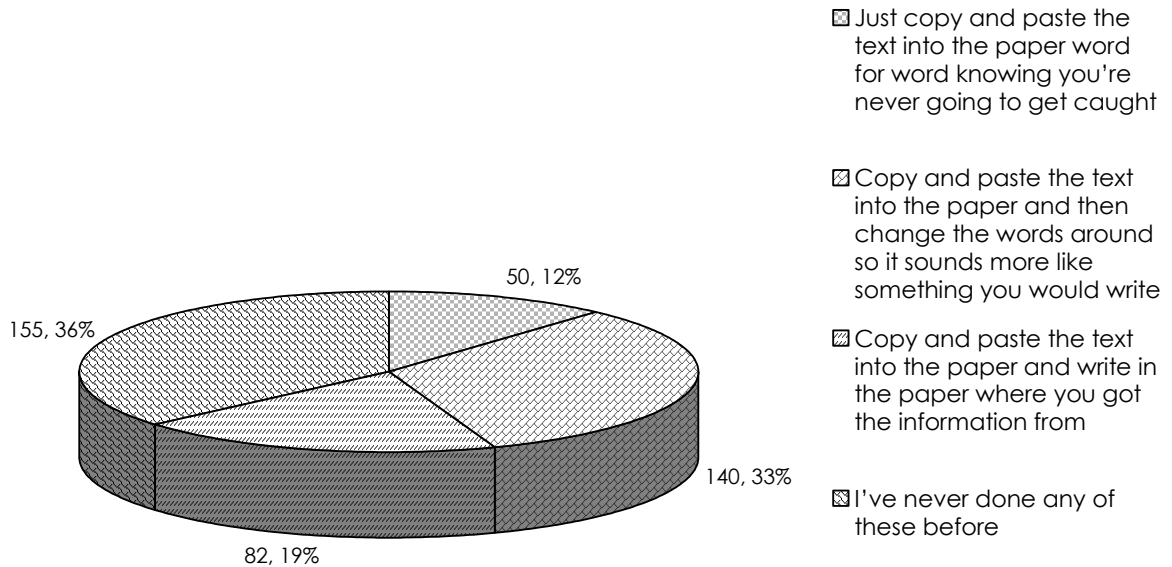

If You Hear A Song On The Radio That You Really Like, You Typically

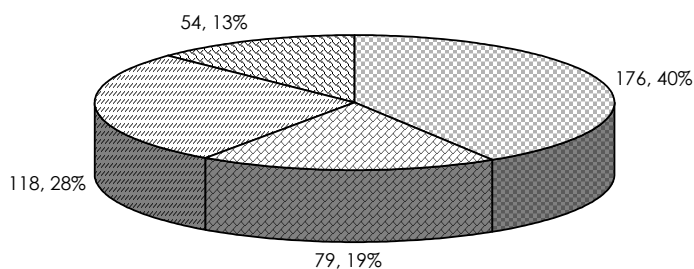

- Go home and download the mp3 from Kazaa or other file sharing service for free
- Have your friend download the song and make a CD for you
- Go out and buy the CD or have your parents buy it for you
- I've never done any of these before

When You Receive A File That You Are Not Expecting, You Typically

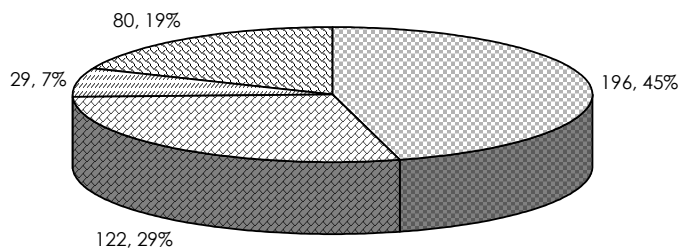

- Delete the file immediately without opening it
- Open the file to see what it is
- Email the sender to find out what the file is
- I've never done any of these before

When You Receive An Email From A Person You Do Not Know, You Typically:

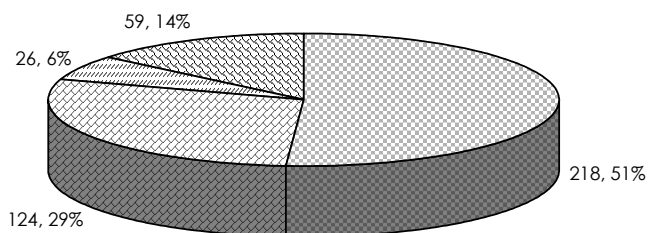

- Delete it without opening it
- Open it to find out what it is
- Email the person back and tell them not to email you again
- I've never done any of these before

An Example Of A Good Password Would Be

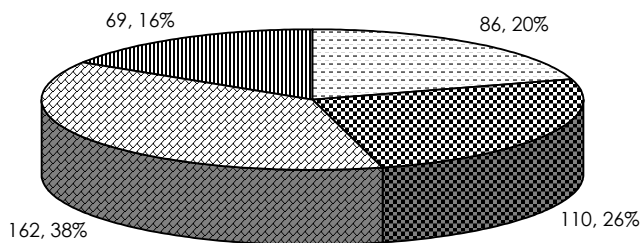

- The name of my favorite character from a TV show
- My pet's name
- Taking a line from a song and using the first initial from each word
- My birthday

If You Are harassed Online By Someone, You Typically:

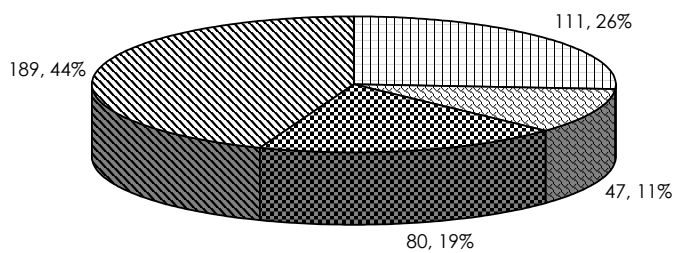

- Give it right back. The guy probably deserves it too
- Ignore it. Sticks and stones and all that
- Report it to the proper authorities or a parent
- Block that person's email and screen name

Your Teacher Leaves A File Open On His Desktop That Contains Next Week's Test And The Answer Key, And You Know He's Not Going To Be Back For Awhile. You:

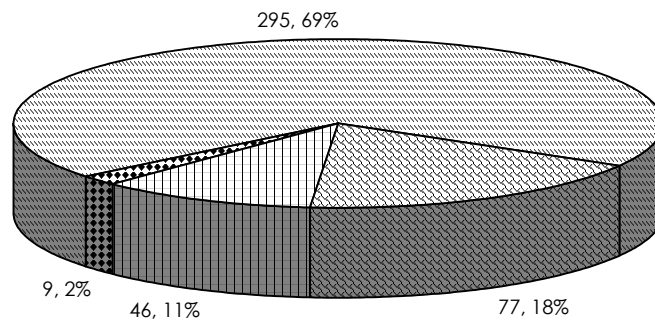

- Print out a copy for yourself because he'd never know someone did
- Minimize the window so no one else knows that he left it up
- Change the questions and answers because he'd never know it was you
- Leave it and avoid temptation